



Technical information **The Citaro LE**



Mercedes-Benz

Model variants

Citaro LE (C628.583)

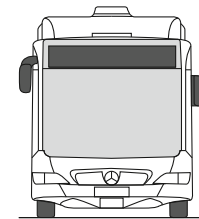
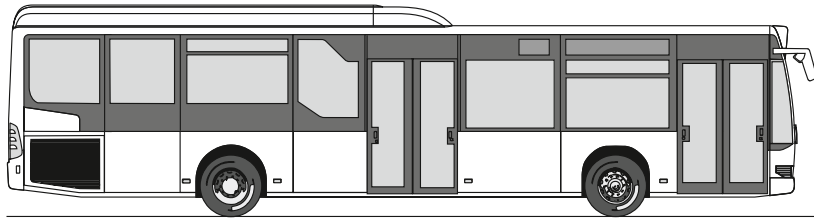

Citaro LE (C628.584)

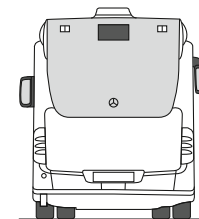
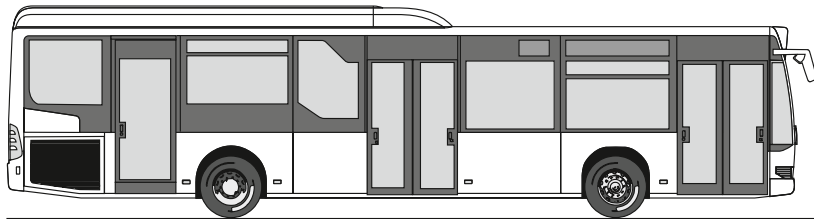

Model variants

Citaro LE Ü (C628.587)

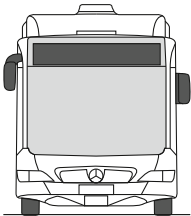
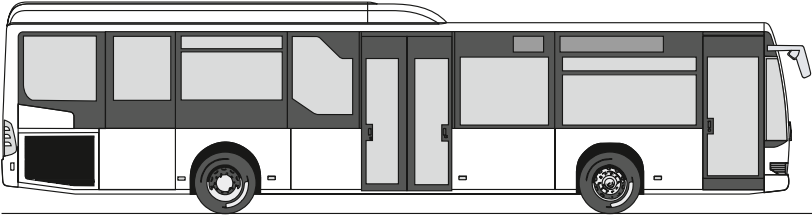

Citaro LE MÜ (C628.687)

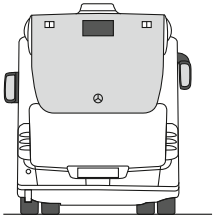
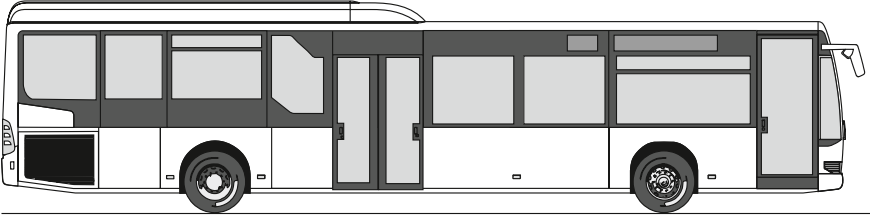

Dimensions/weights

	Citaro LE, 2 doors	Citaro LE, 3 doors	Citaro LE Ü	Citaro LE MÜ
Vehicle length	12,040 mm	12,040 mm	12,040 mm	13,057 mm
Vehicle width	2550 mm	2550 mm	2550 mm	2550 mm
Vehicle height (incl. roof ventilator)	3318 mm	3318 mm	3318 mm	3318 mm
Wheelbase, front axle - drive axle	6035 mm	6035 mm	6035 mm	7052 mm
Overhang, front/rear	2705/3300 mm	2705/3300 mm	2705/3300 mm	2705/3300 mm
Angle of approach/departure	7°/7°	7°/7°	7°/7°	7°/7°
Tyre size	275/70 R 22.5	275/70 R 22.5	275/70 R 22.5	275/70 R 22.5
Overall passenger-carrying capacity	101	101	83	83
Seated	34	31	45	49
Standing	67	70	38	34
Boarding height, door 1/door 2/door 3	320/340/- mm	320/340/340 mm	320/340/- mm	320/340/- mm
Door opening width, door 1/door 2/door 3	1250/1250/- mm	1250/1250/780 mm	780/1250/- mm	780/1250/- mm
Headroom, front/rear	2318/1962 mm	2318/1962 mm	2318/1962 mm	2318/1962 mm
Floor height above road	370 mm	370 mm	370 mm	370 mm
Waist rail height (above floor)	950 mm	950 mm	950 mm	950 mm
Fuel tank capacity	280 l	280 l	350 l	350 l
AdBlue additive tank capacity	38 l	38 l	46 l	46 l
Gross vehicle weight, legally permissible*	18,000 kg	18,000 kg	18,000 kg	18,000 kg
Axle loads, technically permissible				
- Front axle	7245 kg	7245 kg	6930 kg	6930 kg
- Rear axle	13,000 kg	13,000 kg	12,760 kg	12,760 kg

* Depends on country of registration, example shown: Germany

Turning circle

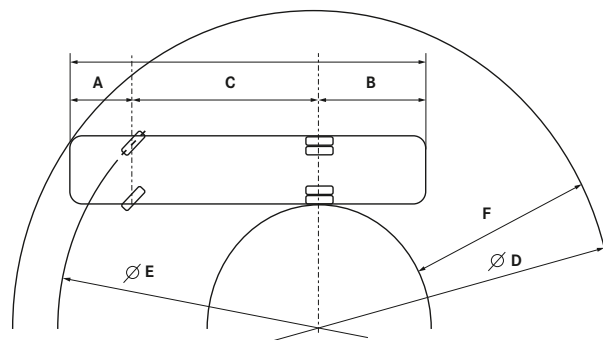

	Citaro LE, 2 doors	Citaro LE, 3 doors	Citaro LE Ü	Citaro LE MÜ
A: Front overhang	2705 mm	2705 mm	2705 mm	2705 mm
B: Rear overhang	3300 mm	3300 mm	3300 mm	3300 mm
C: Wheelbase	6035 mm	6035 mm	6035 mm	7052 mm
D: Minimum turning circle	21,528 mm	21,528 mm	21,528 mm	24,198 mm
E: Minimum track circle	17,406 mm	17,406 mm	17,406 mm	20,072 mm
F: Ring width for minimum turning circle	6845 mm	6845 mm	6845 mm	7309 mm
D: Turning circle as per BOKraft (Ordinance on the Operation of Passenger Transport Companies)	25,000 mm	25,000 mm	25,000 mm	25,000 mm
F: Ring width as per BOKraft (Ordinance on the Operation of Passenger Transport Companies)	5954 mm	5954 mm	5954 mm	7058 mm
F: Maximum permissible ring width as per BOKraft (Ordinance on the Operation of Passenger Transport Companies)	7200 mm	7200 mm	7200 mm	7200 mm
Maximum front-axle wheel angle, inner/outer wheel	53°/46°	53°/46°	53°/46°	53°/46°

Powertrain/technology

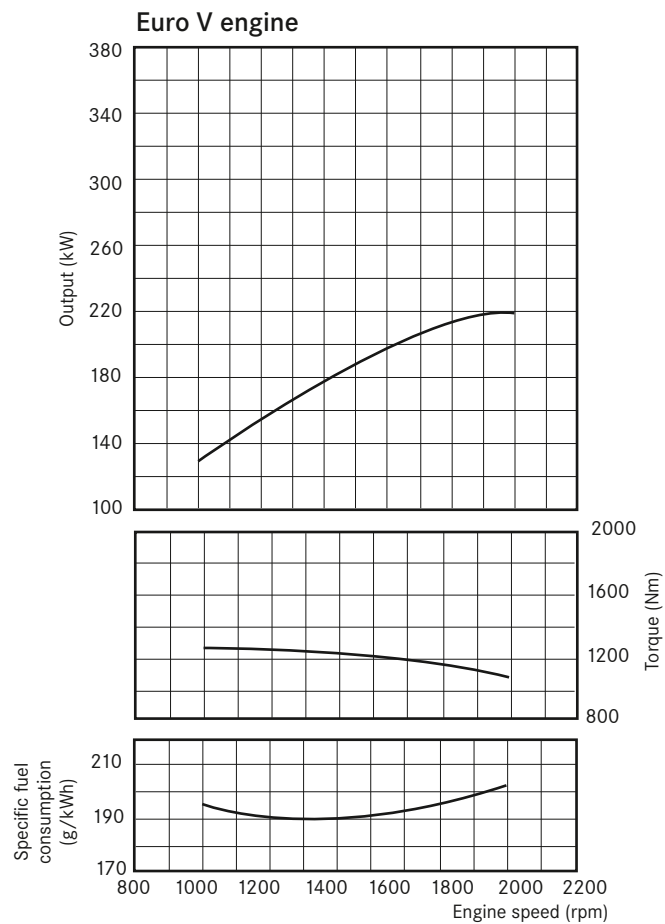

Max. output: 220 kW at 2000 rpm (80/1269/EEC)
 Max. torque: 1250 Nm at 1100 rpm, Torque rise = 19%

Steady-state full-load curves

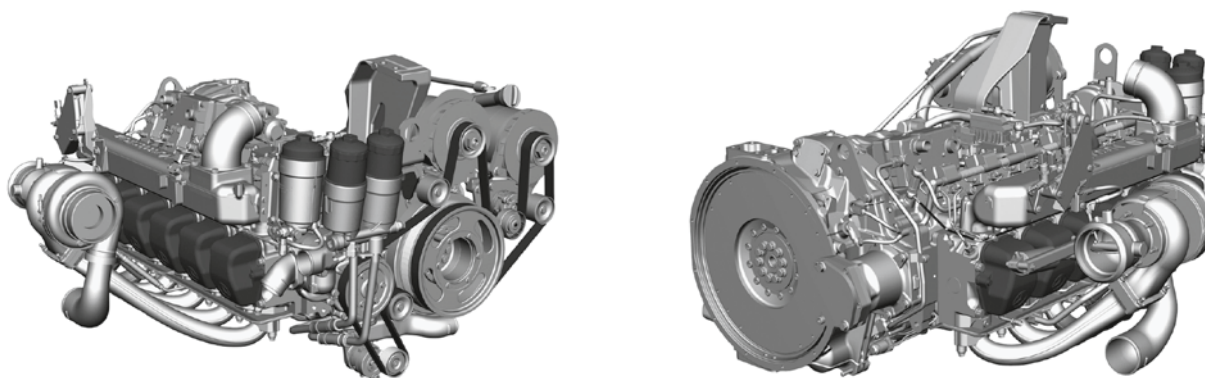

	Citaro LE
Engine (Euro V/EEV*)	OM 457 hLA
Displacement	11,967 cc
Output (standard)	220 kW
Cylinders/arrangement	6/in-line
Max. torque	1250 Nm at 1100 rpm
Transmission	VOITH DIWA 5.0, 4-speed automatic transmission
Axles	
Front axle	ZF, independent suspension
Drive axle	Mercedes-Benz HO 6
Steering	ZF, power steering
Brakes	Electronic braking system with disc brakes Anti-lock braking system (ABS)

* Our buses achieve the EEV emission standard (optional), depending on model and power unit, with or without a diesel particulate filter.

Citaro LE (C628.583) seating configurations

Standard

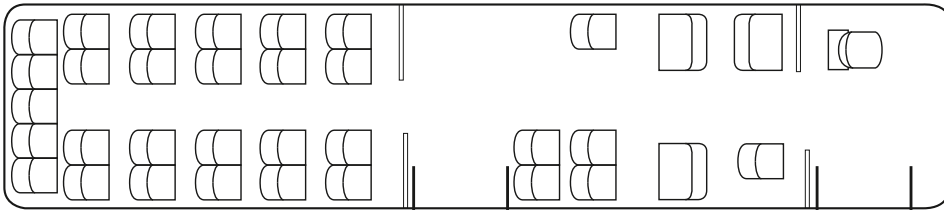

Number of seats

34

Special equipment (example)

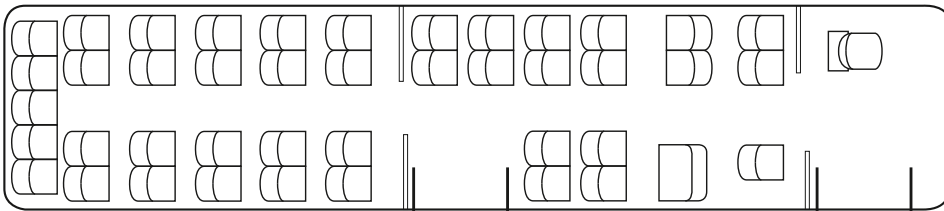

Number of seats

43

Special equipment (example)

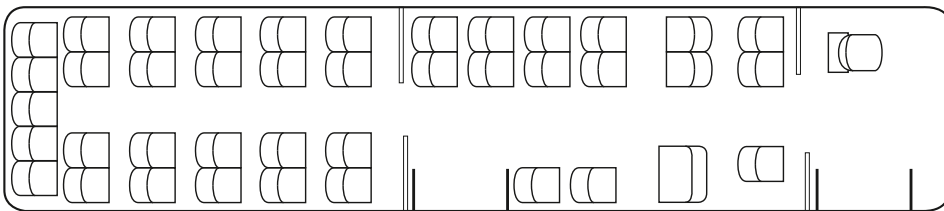

Number of seats

41

Citaro LE (C628.584) seating configurations

Standard

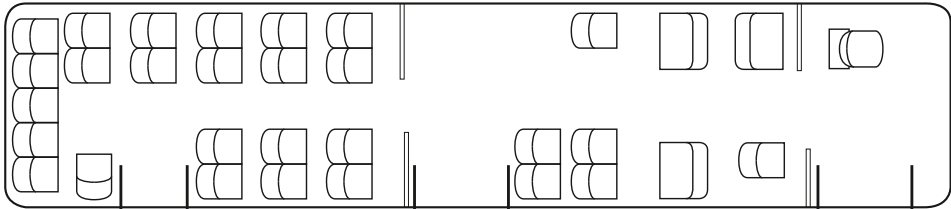

Number of seats 31

Special equipment (example)

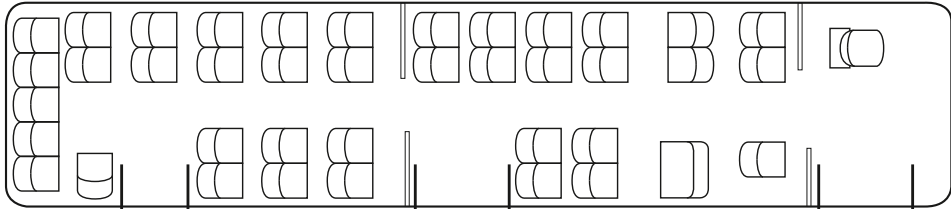

Number of seats 40

Special equipment (example)

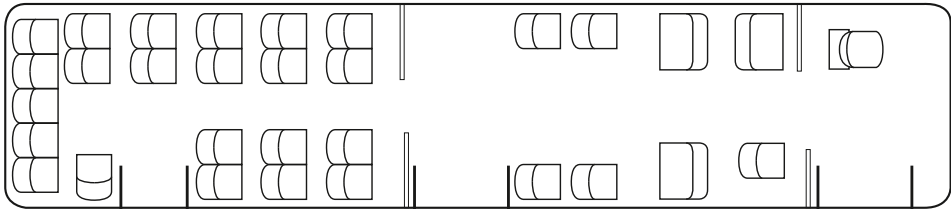

Number of seats 30

Citaro LE Ü (C628.587) seating configurations

Standard

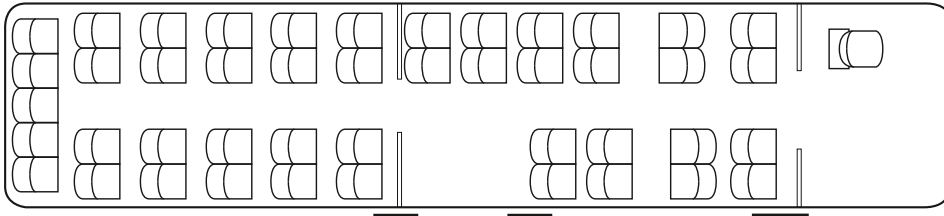

Number of seats

45

Special equipment (example)

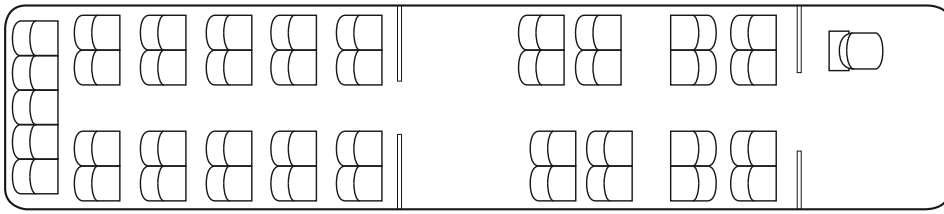

Number of seats

41

Special equipment (example)

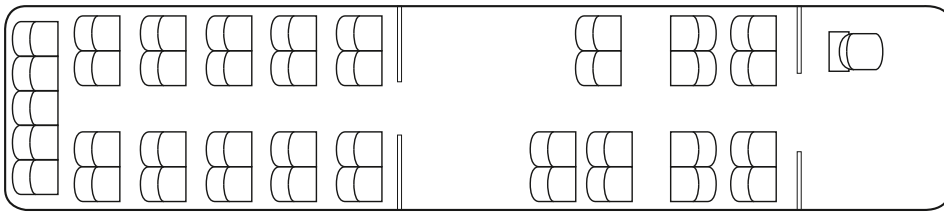

Number of seats

39

Citaro LE MÜ (C628.687) seating configurations

Standard

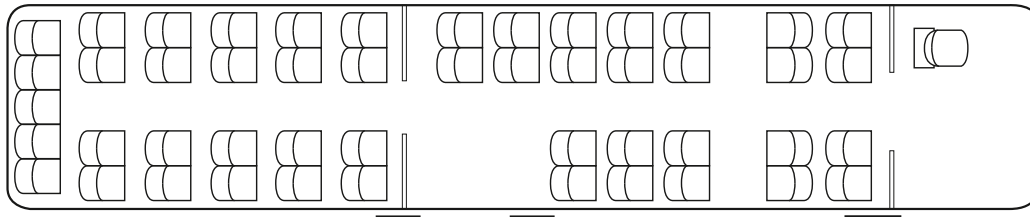

Number of seats

49

Special equipment (example)

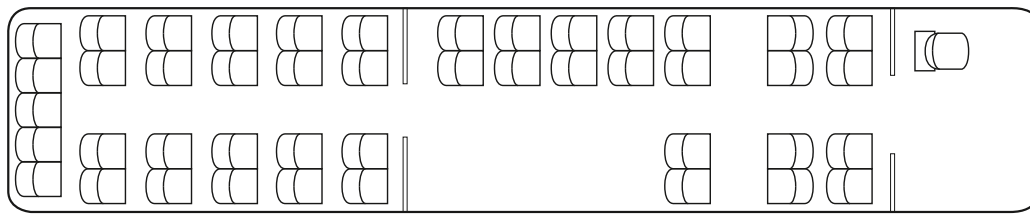

Number of seats

45

Special equipment (example)

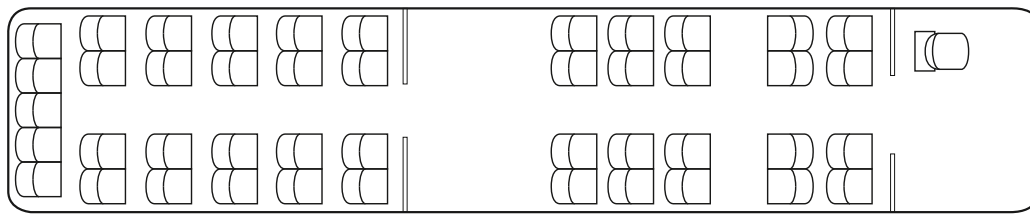

Number of seats

45

Standard/special equipment (selection)

Engine and chassis	Citaro LE, 2 doors	Citaro LE, 3 doors	Citaro LE Ü	Citaro LE MÜ
Engine: Mercedes-Benz OM 457 hLA 220 kW (Euro V)	●	●	●	●
Engine: Mercedes-Benz OM 457 hLA 260 kW (Euro V)	○	○	○	○
EEV emissions standard	○	○	○	○
VOITH DIWA 5.0, 4-speed automatic transmission	●	●	●	●
ZF Ecomat/Ecolife, 6-speed automatic transmission	●	●	●	●
Electronic braking system (EBS)	●	●	●	●
Anti-lock braking system (ABS)	●	●	●	●
Acceleration skid control (ASR)	○	○	○	○
Frequent-stop brake with drive-off lock	●	●	●	●
Air suspension by means of electronic level control (ENR)	●	●	●	●
Air suspension by means of electronic level control (ENR), including kneeling function	○	○	○	○
Vehicle height increase of 70 mm using button on instrument panel/console	○	○	○	○
Painted wheels/painted wheel trims	○	○	○	○
Plastic wheel trims	○	○	○	○
Stainless-steel wheel trims	○	○	○	○

● Standard equipment/no-cost option

○ Special equipment

Air conditioning system	Citaro LE, 2 doors	Citaro LE, 3 doors	Citaro LE Ü	Citaro LE MÜ
Turbo roof ventilator	●	●	●	●
Roof-duct ventilation system with integrated heating	○	○	○	○
Roof-mounted air conditioning system, uprated version	○	○	○	○
Electrically opening roof hatch with automatic closing function (windscreen wipers activated)	●	●	●	●
Heating system with sidewall radiators	●	●	●	●
Heating system with convectors	○	○	○	○
Driver's area				
Driver's seat GRAMMER MSG 90.6, air-sprung	●	●	●	●
ISRI 6860/875 driver's seat, integrated pneumatic system, three-point seat belt	○	○	○	○
Heated driver's seat	●	●	●	●
Driver's area air conditioning	○	○	○	○
Driver's cab door	●	●	●	●
Compartment for driver's bag on driver's cab door, open	●	●	●	●
Compartment for driver's bag on driver's cab door, lockable, hinged	○	○	○	○
Ticket printer installation option	●	●	●	●
Steering column adjustable for height and angle, with steering wheel lock	●	●	●	●
Cruise control	○	○	○	○
Heated exterior mirrors approved for school buses	●	●	●	●
Heated exterior mirrors, electrically adjustable, approved for school buses	○	○	○	○
Driver microphone	○	○	○	○
Audible reversing warning/reversing camera	○	○	○	○
Roller sunblind covering 2/3 of the windscreen, electrically operated	○	○	○	○
Interior video monitoring	○	○	○	○
Fire detection system for monitoring engine compartment (Standard as of 2011)	○	○	○	○
Extinguisher system	○	○	○	○

● Standard equipment/no-cost option

○ Special equipment

Interior	Citaro LE, 2 doors	Citaro LE, 3 doors	Citaro LE Ü	Citaro LE MÜ
City Star Eco (CSE) seats	●	●	-	-
City Star Function (CSF) seats	●	●	-	-
Inter Star Eco (ISE) seats	-	-	●	●
Wheelchair space	○	○	○	○
Wheelchair parking wall with integral folding seat	○	○	○	○
Stop request button	●	●	●	●
Stowage facility on front left wheel arch	○	○	○	○
Emergency hammers secured by rope, automatic retractor	●	●	●	●
Emergency hammers with electric anti-theft alarm	○	○	○	○
Sidewall lining, needlefelt	○	○	○	○
Coat hooks on window pillars	○	○	○	○
Other				
Halogen fog lamps integrated in the bumper	○	○	●	●
Heat-insulating side windows, grey-tinted, single-glazed	○	○	○	○
Double-glazed side windows	○	○	○	○
Hinged windows in side windows	●	●	●	●
Sliding windows in side windows	○	○	○	○
Folding ramp at door 1 or 2, manually operated	○	○	○	○
Cassette ramp at door 2, manually or electrically operated	○	○	○	○
Ski-box bracket	○	○	○	-

● Standard equipment/no-cost option

○ Special equipment

Information and entertainment	Citaro LE, 2 doors	Citaro LE, 3 doors	Citaro LE Ü	Citaro LE MÜ
Radio system with CD player	<input type="radio"/>	<input type="radio"/>	<input type="radio"/>	<input type="radio"/>
Multifunction aerial for radio, mobile phone, navigation	<input type="radio"/>	<input type="radio"/>	<input type="radio"/>	<input type="radio"/>
Interior bus-stop indicator, on transverse duct	<input type="radio"/>	<input type="radio"/>	<input type="radio"/>	<input type="radio"/>
LED or LCD destination display	<input type="radio"/>	<input type="radio"/>	<input type="radio"/>	<input type="radio"/>
Wheelchair pushbutton, interior/exterior	<input type="radio"/>	<input type="radio"/>	<input type="radio"/>	<input type="radio"/>
GPS digital clock on front flap/on transverse roof duct	<input type="radio"/>	<input type="radio"/>	<input type="radio"/>	<input type="radio"/>

● Standard equipment/no-cost option

○ Special equipment

Technical changes may have been made to the product since this data sheet went to press. This data sheet presents only a selection of the possible equipment. Some items of equipment are not available in all countries. The manufacturer reserves the right to make technical changes to the product. For current and more specific information, please contact your Mercedes-Benz sales advisor.

Glossary

Anti-lock braking system (ABS)

The braking forces acting on each wheel are distributed by ABS in such a way that none of the wheels locks for a significant length of time, even during emergency braking. Steering control of the bus is thus largely maintained.

Acceleration skid control (ASR)

ASR prevents the wheels from spinning when moving off on a slippery surface. It only delivers as much power as the driven wheels can transmit to the road surface. Spinning of individual wheels, on ice at the edge of the road, for example, is prevented by precisely metered brake applications.

Electronic level control system (ENR)

Passengers and baggage are not always distributed evenly throughout the vehicle. This can cause variations in the ride height at different wheels. The electronic level control system automatically controls the ride height at each wheel so that the boarding height is always the same.

Electronic braking system (EBS)

Developed from the conventional compressed-air brake, the Electronic Braking System offers many benefits. During braking, the control unit first calls on the permanent brake (retarder). If greater deceleration is required, the control unit uses information from the data network to calculate the optimum brake pressure for each axle. The Electronic Braking System enables considerably shorter stopping distances as well as significantly reduced wear of brake discs and pads.

Cathodic dip priming

Cathodic dip priming (CDP) is an electrochemical process in which the bodyshell is coated by immersion. It is well-suited to priming complex structures and large volumes. The water-based primer provides the bus with outstanding corrosion protection because the layer of paint is applied to every point of the body, covering them all to the same thickness. Cathodic dip priming is demonstrably the best method of corrosion protection currently available in the vehicle manufacturing sector.

For further information, please contact your Mercedes-Benz bus/coach representative.
Or visit us online at www.mercedes-benz.de/omnibus

The illustrations may show special equipment and accessories which are not part of the standard specification.

The technical data in this document apply to Germany (Status: July 2010). The manufacturer reserves the right to make changes to the product.